



- RF Filter Designed for Front End GPS Applications
- Excellent Rejection
- 1.45 x 1.15 mm Surface-Mount Case
- Complies with Directive 2002/95/EC (RoHS)



SF1186K-3

**1575.42 MHz
SAW Filter**

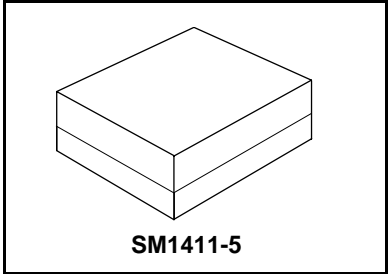

Absolute Maximum Ratings

Rating	Value	Units
Maximum Incident Power in Passband	+10	dBm
Maximum DC Voltage On any Non-ground Terminal	3	VDC
Operating Temperature Range	-40 to +95	°C
Component Storage Temperature Range	-40 to +105	°C
Storage Temperature Range in Tape and Reel	-40 to +85	°C
Maximum Soldering Temperature Profile (5 cycles maximum)	265 °C for 10 s	

Electrical Characteristics

Characteristic	Sym	Notes	Min	Typ	Max	Units
Center Frequency	f_C		1575.42			MHz
2 dB Bandwidth				40		MHz
Insertion Loss, 1574.42 to 1576.42 MHz	IL_{MAX}			0.9	1.5	dB
Amplitude Ripple, 1574.42 to 1576.42 MHz				0.1	0.75	dB _{p-p}
Rejection Referenced to IL_{MAX}						dB
DC to 1450 MHz			35	38		
1450 to 1520 MHz			30	45		
1625 to 1640 MHz			45	48		
1640 to 1805 MHz			38	40		
1805 to 1910 MHz			38	40		
1910 to 2000 MHz			38	43		
2000 to 4000 MHz			30	45		
4000 to 6000 MHz			20	22		
VSWR, 1574.42 to 1576.42 MHz				1.15	1.6	
Terminating Source impedance	Z_S			50		Ω
Terminating Load impedance	Z_L			50		Ω
Case Style			SM1411-5			
Lid Symbolization \square = year/month manufacturing code			2□			



CAUTION: Electrostatic Sensitive Device. Observe precautions for handling.

Notes:

1. US and international patents may apply.
2. RFM, stylized RFM logo, and RF Monolithics, Inc. are registered trademarks of RF Monolithics, Inc.

Frequency Response Plots

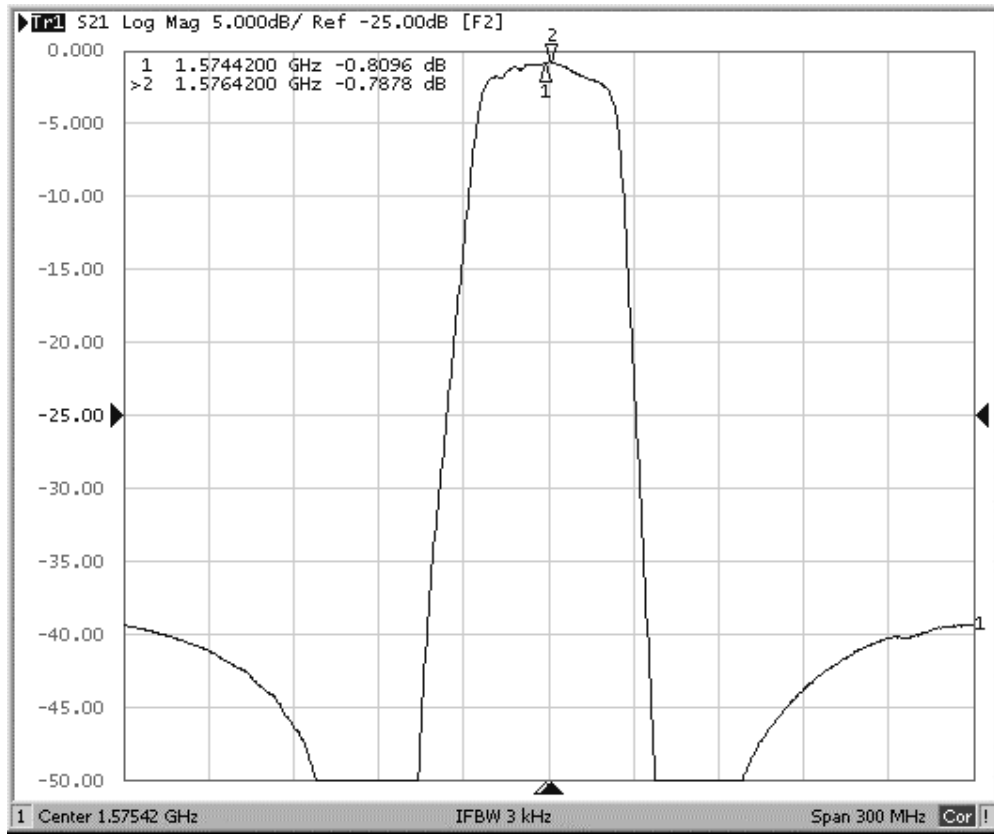

Input VSWR Plot

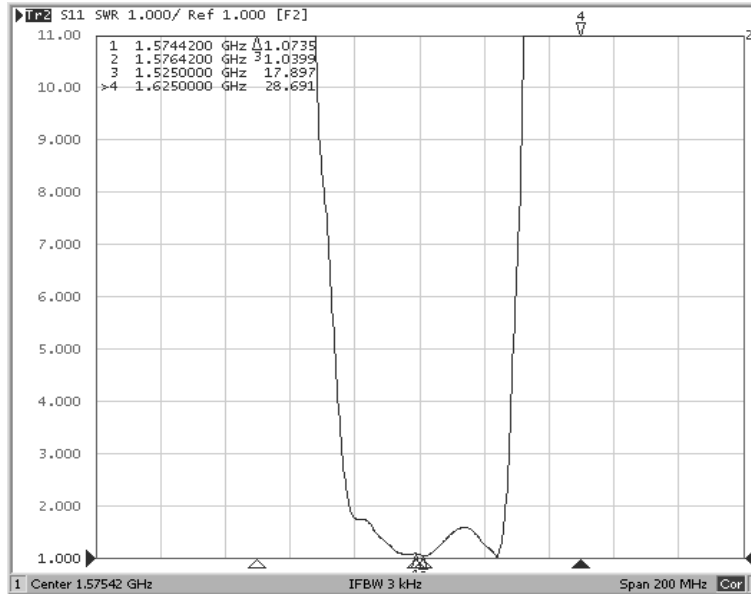

Output VSWR Plot

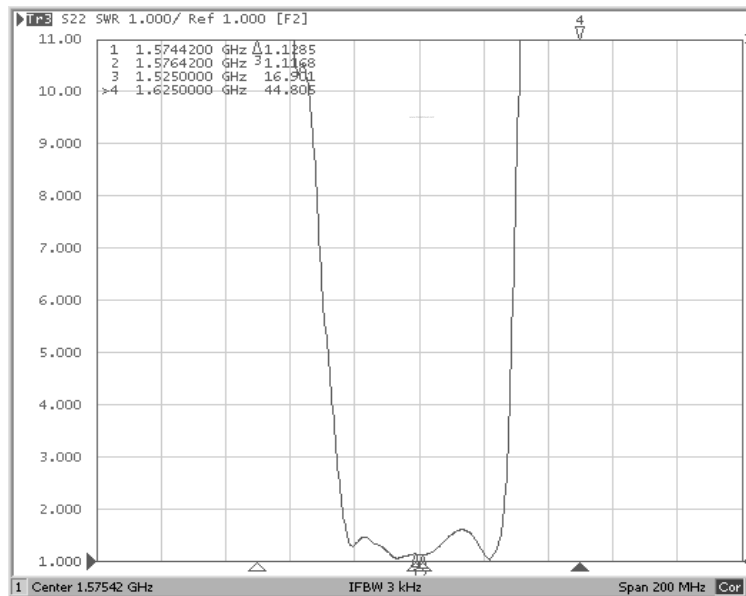

SM1411-5 Case

5-Terminal Surface-Mount Case 1.45 X 1.15- mm Nominal Footprint

Electrical Connections

Connection	Terminals
Input	C
Output	A
Ground	B, D, E

Package Dimensions

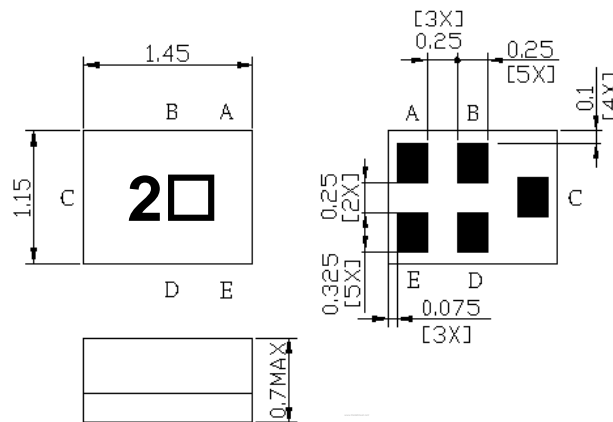

Circuit Board Footprint

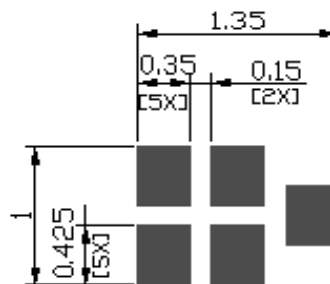

Test Circuit

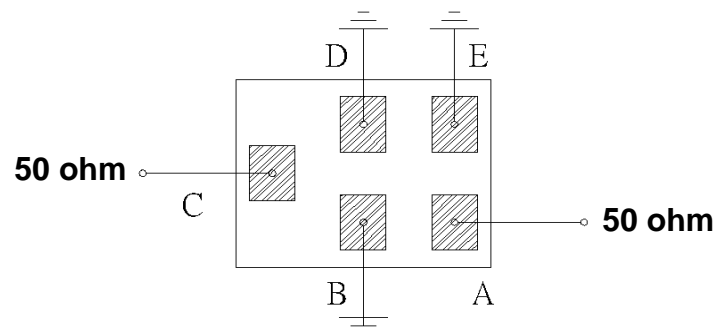

Reel Dimensions - 7 inch Reel, 3000 Filters

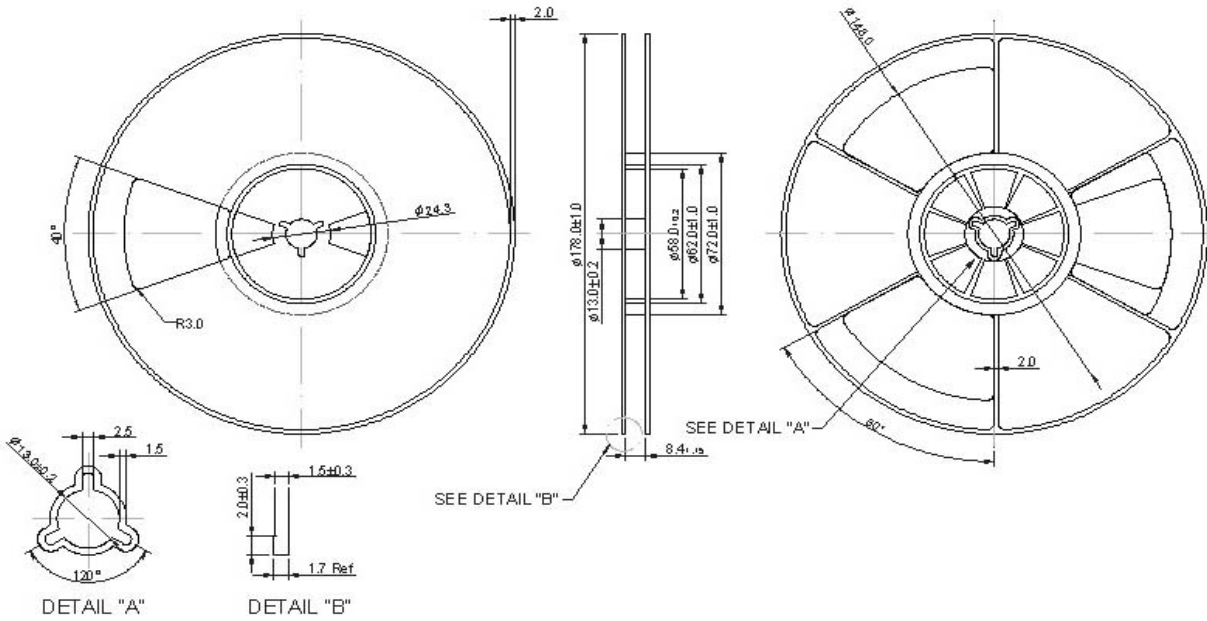

Tape Dimensions

